

***TECHNICAL  
INFORMATION***

---

**CITIZEN QUARTZ  
Cal.No.75※※※**

1. OUTLINE



This is a compact and thin-type analog quartz crystal watch for ladies featuring "center second". It adds to an array of Citizen analog quartz watches for ladies including the bracelet to the calendar-equipped watch. Especially, a two-year life of the power cell has been achieved with this watch for the first time in Citizen for the calendar-equipped watch for ladies.

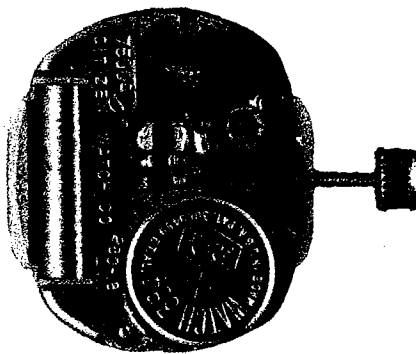

Movement  
(Quartz crystal oscillator side)

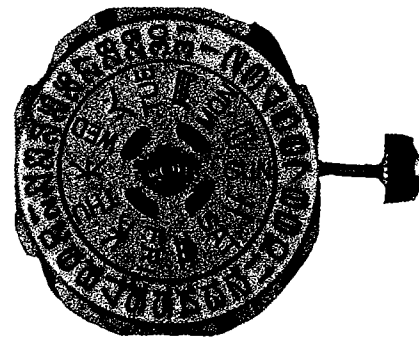

Movement  
(Dial side)

## **2. FEATURES**

### **1) Thin-type compact analog quartz crystal watch**

The size of the movement is set identical to those of O1-series watches, with adoption of a different shape of the calendar plate as well as block formation of the component parts. As a result, the watch can meet versatile specifications in an excellent design.

### **2) Indicating device for power cell life**

When the power cell life comes near its end and the power cell voltage lowers, the normal 1-second step movement of the second hand changes to the 2-second step movement.

### **3) Second hand stopping at optional positions**

The second hand can be stopped at an optional position when the crown is set at the time setting position. With this device, the time can be set correctly down to a second.

### **4) Power-conservation switch**

When the crown is set at the time setting position, the power-conservation switch is actuated to extend the life of the power cell.

### **5) Non-stop operation for about two years with only one power cell**

Thanks to a step motor excelling in the conversion efficiency as well as the electronic circuit featuring a low current driving, only one small-size silver oxide power cell can operate the watch accurately and continuously for about two years.

### 3. HANDLING INSTRUCTIONS

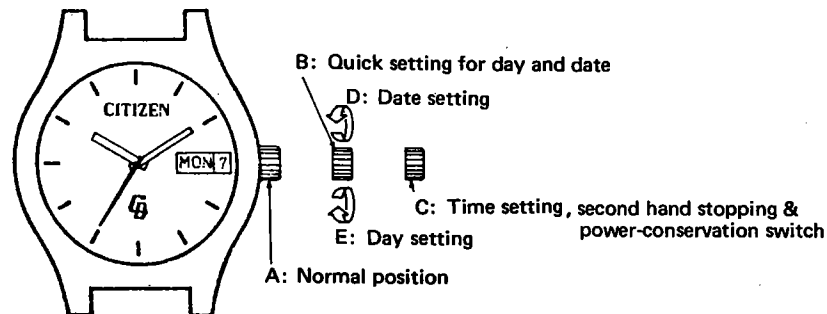

(The explanation of the drawing is of 7500A)

- 1) **Set the time.**  
Pull out the crown up to C position and move the hands to set the time making sure AM or PM. If the date changes at 12 o'clock, it indicates 12 midnight.
- 2) **Push the crown lightly.**  
The watch begins to operate.
- 3) **Set the day and date.**  
Turn the crown counterclockwise at B position to set the date and turn clockwise to set the day respectively.  
The day is displayed bilingually—English and Japanese alternately. Choose either one language, and the language is displayed continuously thereafter.
- 4) **Push the crown completely into A position.**  
The day and date change automatically while the watch is used.

4. STRUCTURE AND FUNCTION

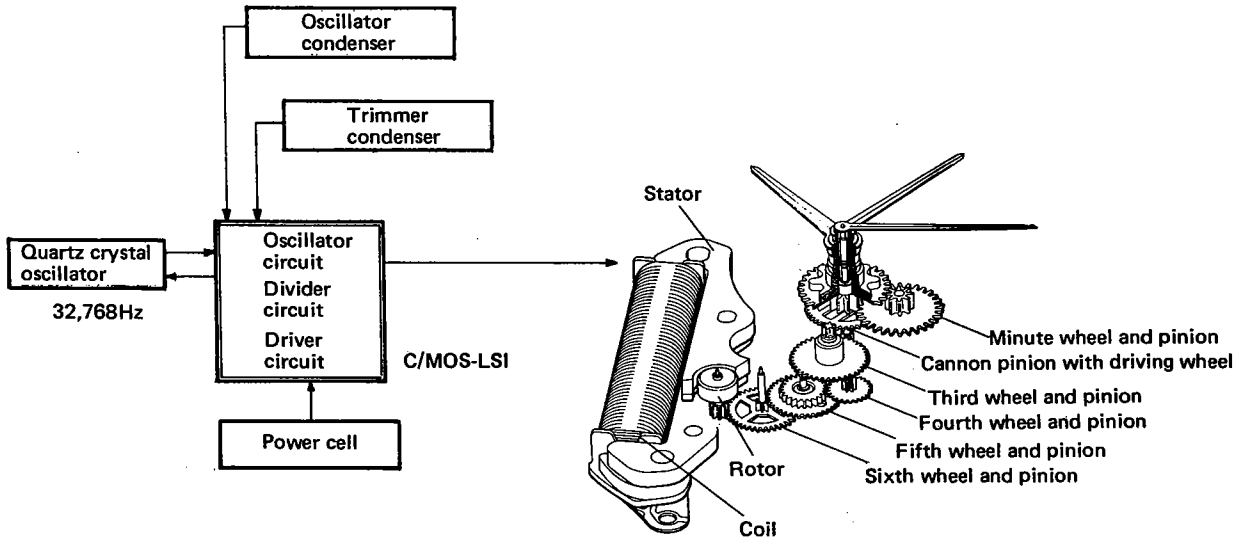

1) Driving mechanism

A highly stabilized oscillation of 32,768Hz produced by a quartz crystal oscillator is divided down to 1 Hz through the divider circuit. The divided pulse of 1 Hz is then amplified through the driver circuit up to a level strong enough to actuate the rotor. At the same time, the pulse is converted to turn + and - alternately every second. With this pulse, the step motor is actuated. The step motor consists of the driving coil, stator and rotor. The rotor is composed of a permanent magnet of Sm-Co (samarium-cobalt), and two poles (a pair) are magnetized at the circumference. The stator, finished with a stage-difference adjustment, is located as if it covered the circumference area of the rotor. Each stator is pressure-bonded across the core of the driving coil to form the magnetic path. And the ⊕ and ⊖ pulses flowing the driving coil convert the magnetic pole of the stator into the N and S poles alternately. Owing to this intermittent conversion of the magnetic pole occurring at the stator, the rotor has repulsion and attraction to given an instantaneous rotation by 180° in a fixed direction.

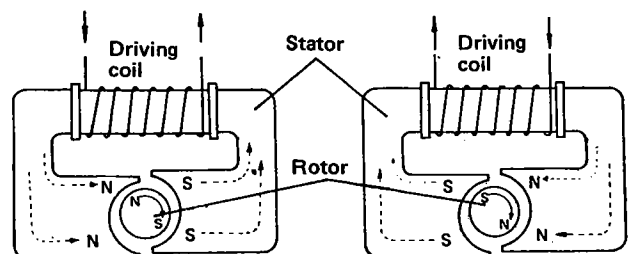
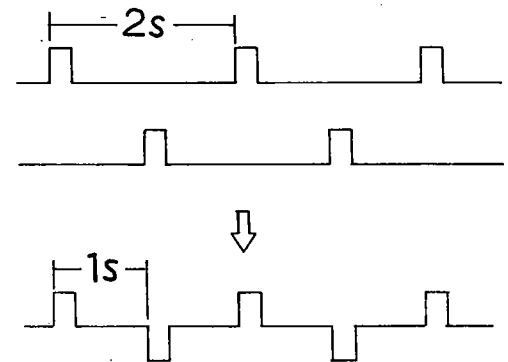

## 2) Structure of movement

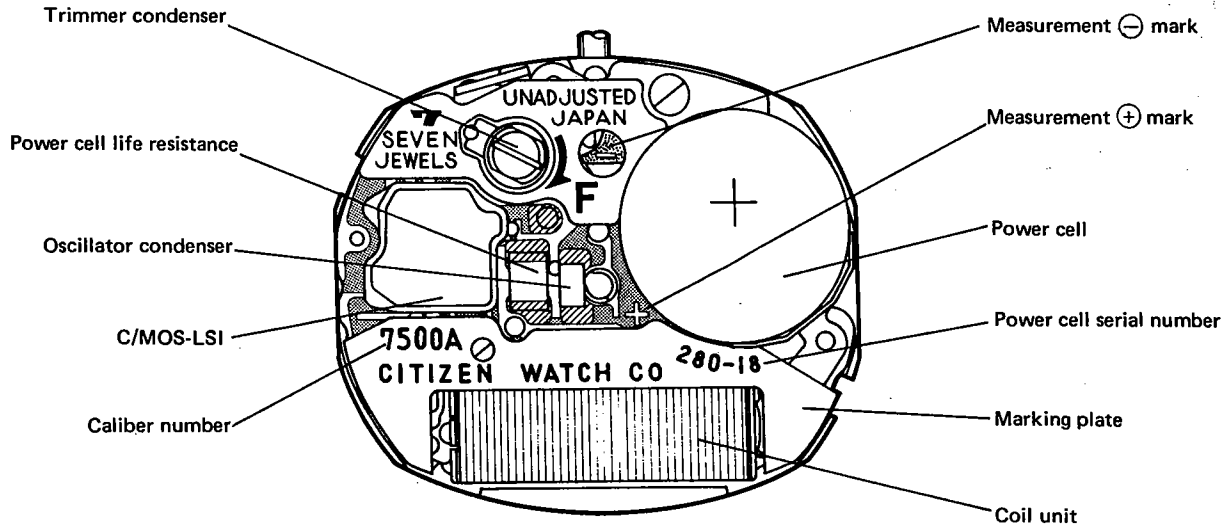

The movement comprises quartz crystal oscillator, C/MOS-LSI, trimmer condenser, converter, power cell, and train wheels. To facilitate an easy troubleshooting and adjustment, the adjusting direction of the trimmer condenser and the puls (+) and minus (−) terminals for measurement are indicated in marks.

## 3) Start/stop and dial side mechanism

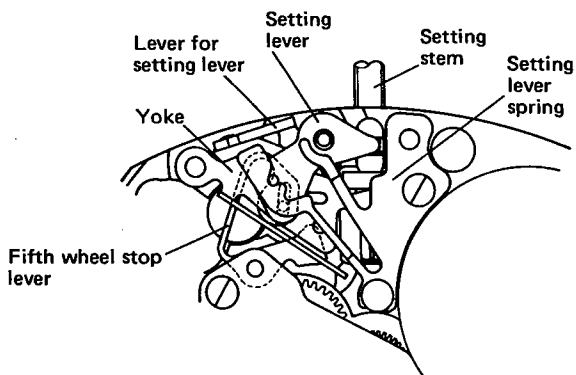

With the crown pulled out two steps, the reset switch is actuated and the division output is held up. Thus, the power-conservation state is secured, and the second hand stops just on the second scale at that moment. At the same time, the fifth wheel stop mechanism operates to stop and fix the train wheels with the hand turning torque.

When the crown is pushed in, the hands begin to start again in one minute.

5. SPECIFICATIONS

Caliber Nos.		7500A	7510A	7530A
Type		Analog quartz watch (center second)		←
Movement	Size (short dia. x long dia.)	16.3 x 17.8mm	←	15.3 x 17.8mm
	Thickness	5.03mm	←	4.05mm
Oscillation		32,768Hz		
Accuracy		±15 sec. per month (under normal temperature)		
Effective temperature range		-10°C ~ +60°C (14°F ~ 140°F)		
Converter		Step motor (1-sec. step movement)		
Integrated circuit		C/MOS-LSI (1 unit)		
Additional mechanisms	Date	○	○	X
	Day	○	X	X
	Bilingual day display	○	X	X
	Date quick setting	○	○	X
	Day quick setting	○	X	X
	Optional second hand stopping	○	○	○
	Power-conservation switch	○	○	○
Power cell	Parts No.	280-18	←	←
	Voltage	1.5V	←	←
	Capacity	35mAH	←	←
	Size	7.9φ x 3.6mm	←	←
	Life	About 2 years	←	←

6. DISASSEMBLY/ASSEMBLY OF MOVEMENT WITH LUBRICATION

Disassembling sequence: ① → ③⑥ (shown in diagram)  
 Assembling sequence: ③⑥ → ①

The number of the screw coming with the parts is shown in a symbol like ( T 3 ).  
 The kinds of oil and the area to be lubricated are indicated with the following marks.

Ⓐ Synt-A-Lube oil      Ⓥ Synt-V-Lube oil

Use the movement holder exclusive for Cal. No. 75-series watches.

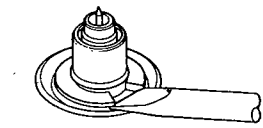
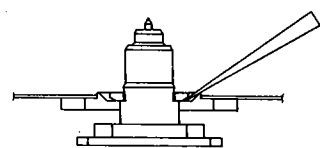
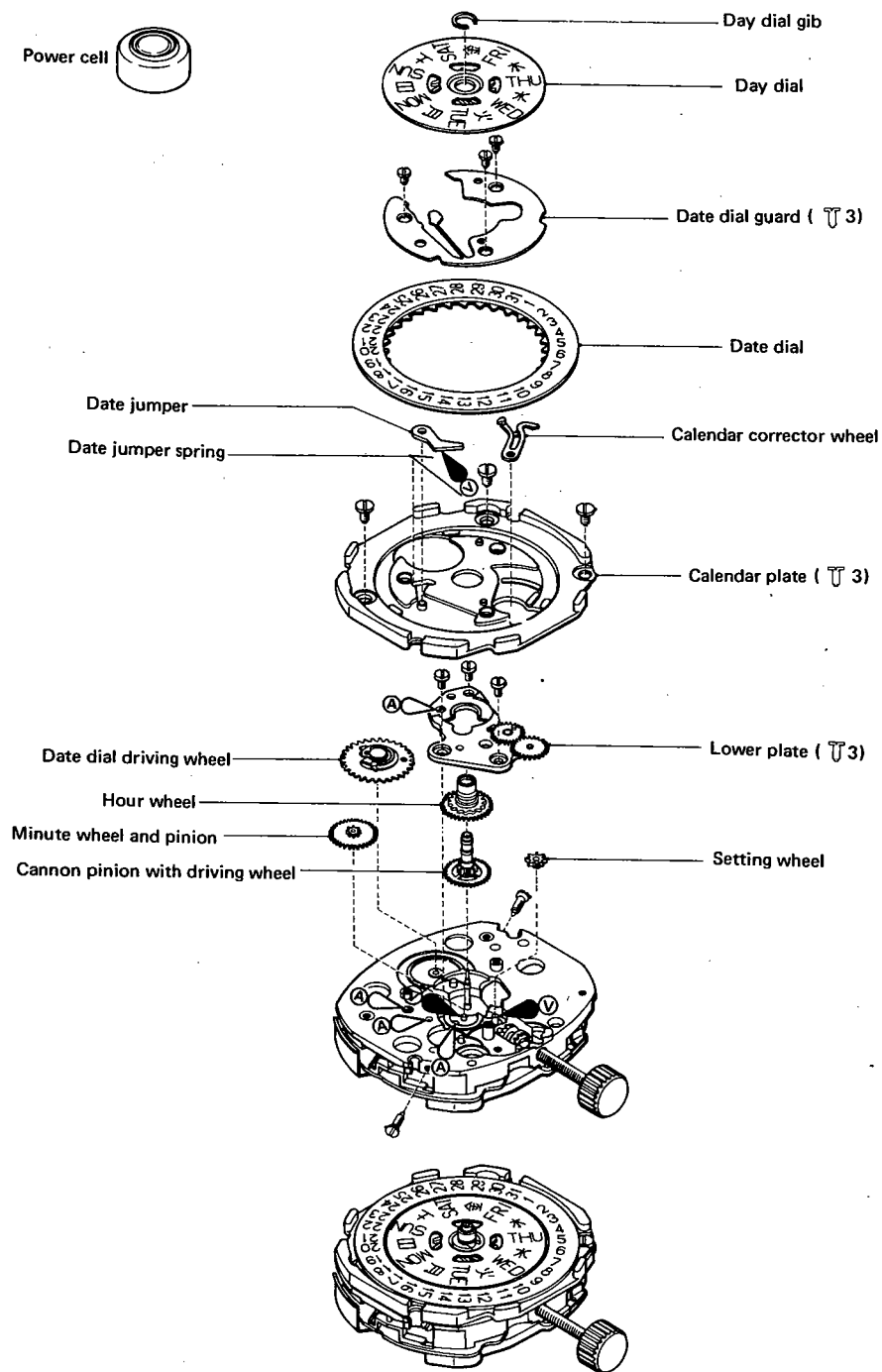

To remove the day dial gib insert a driver into a groove as shown in the diagram and pry the rest open.

Apply CH-1 oil to the slip-area between wheel and pinion of the cannon pinion with driving wheel.



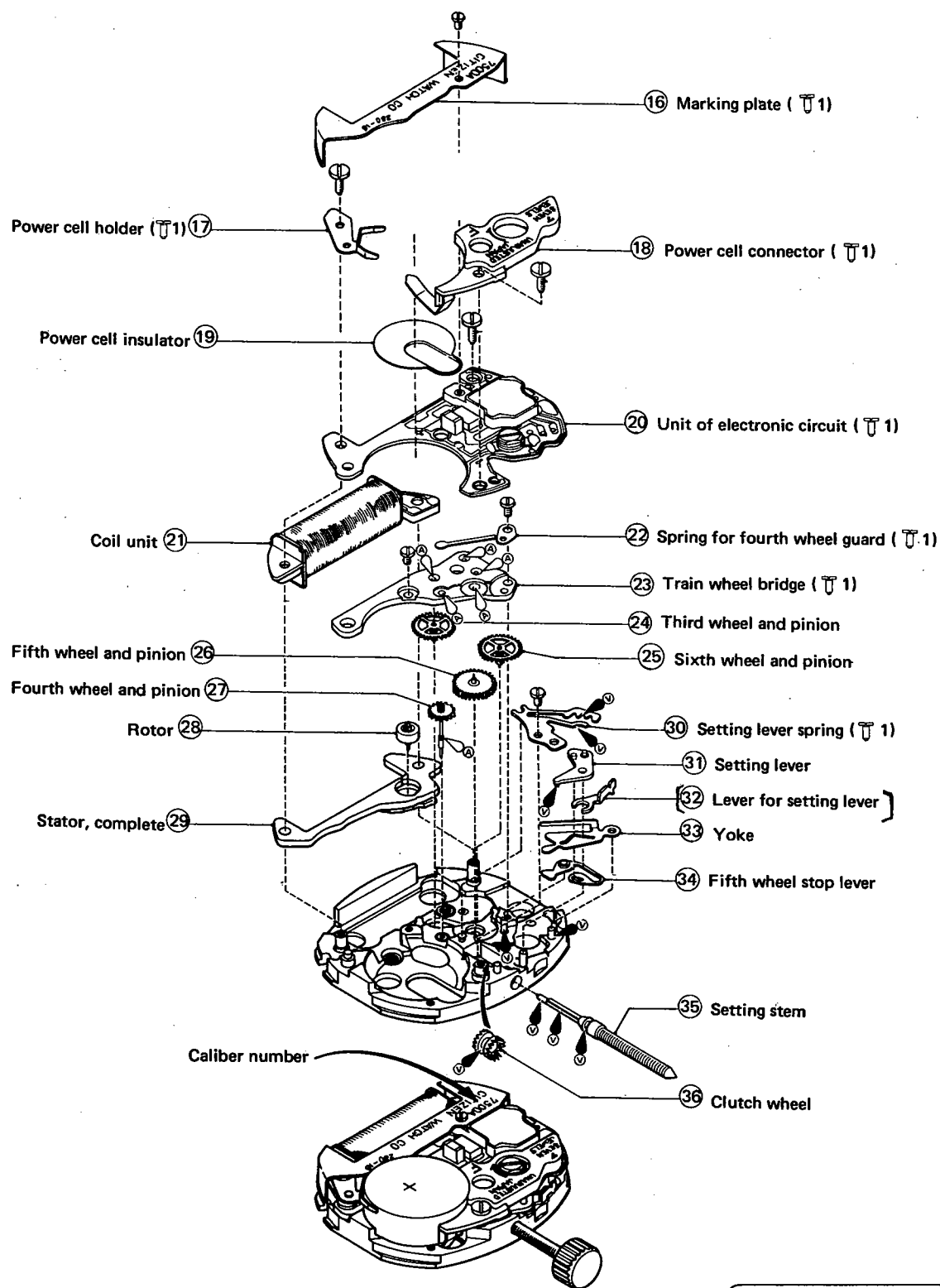

Never fail to incorporate the lever for setting lever into the movement.  
 The lever for setting lever belongs to the appearance parts.

7. TROUBLESHOOTING AND ADJUSTMENT

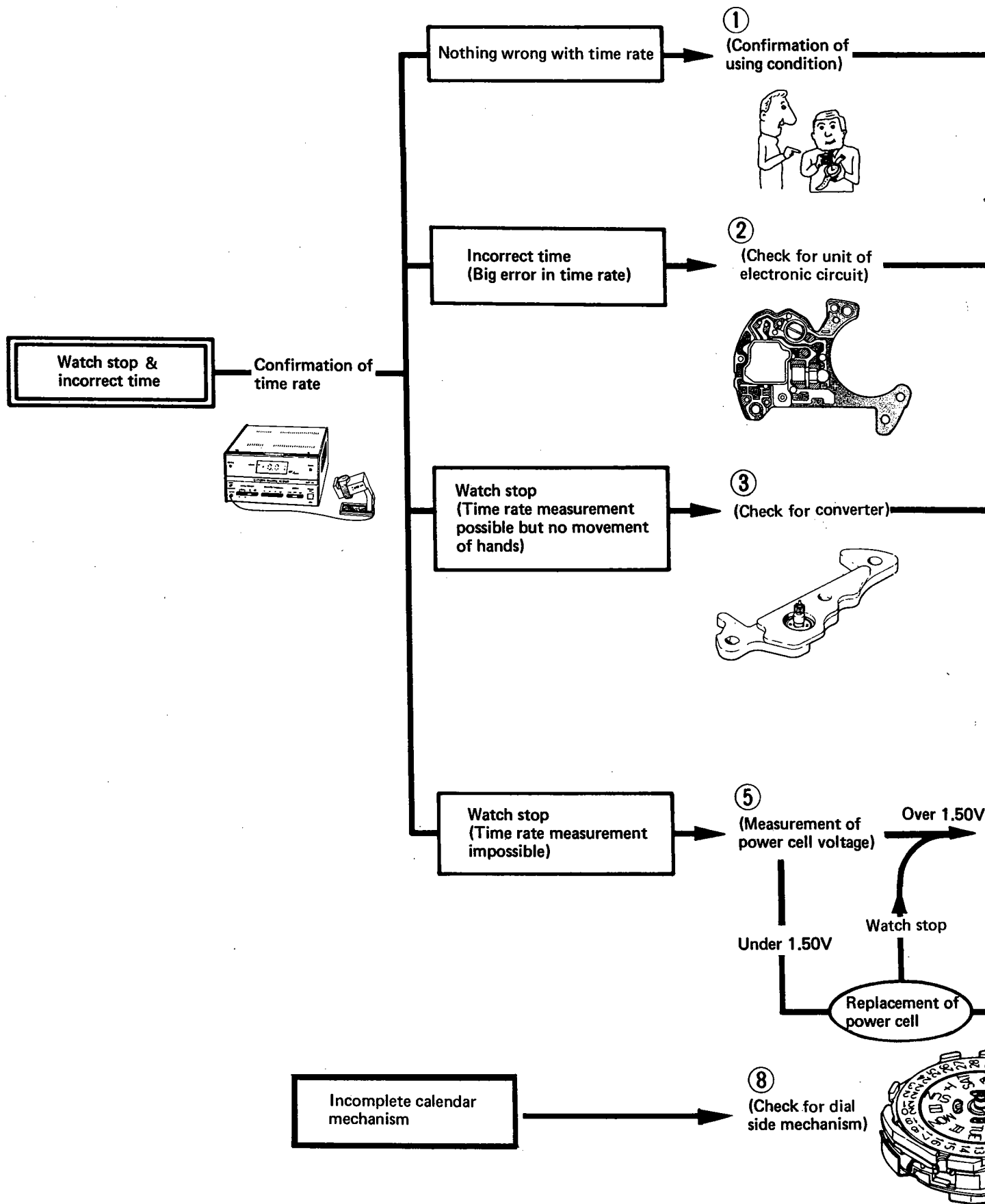

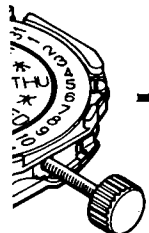
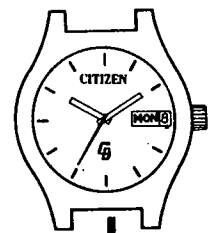
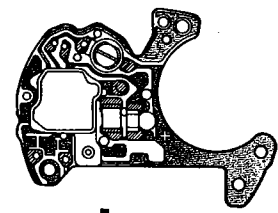
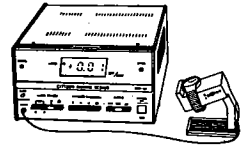
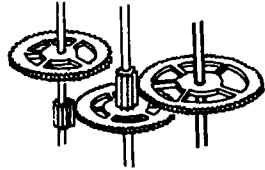
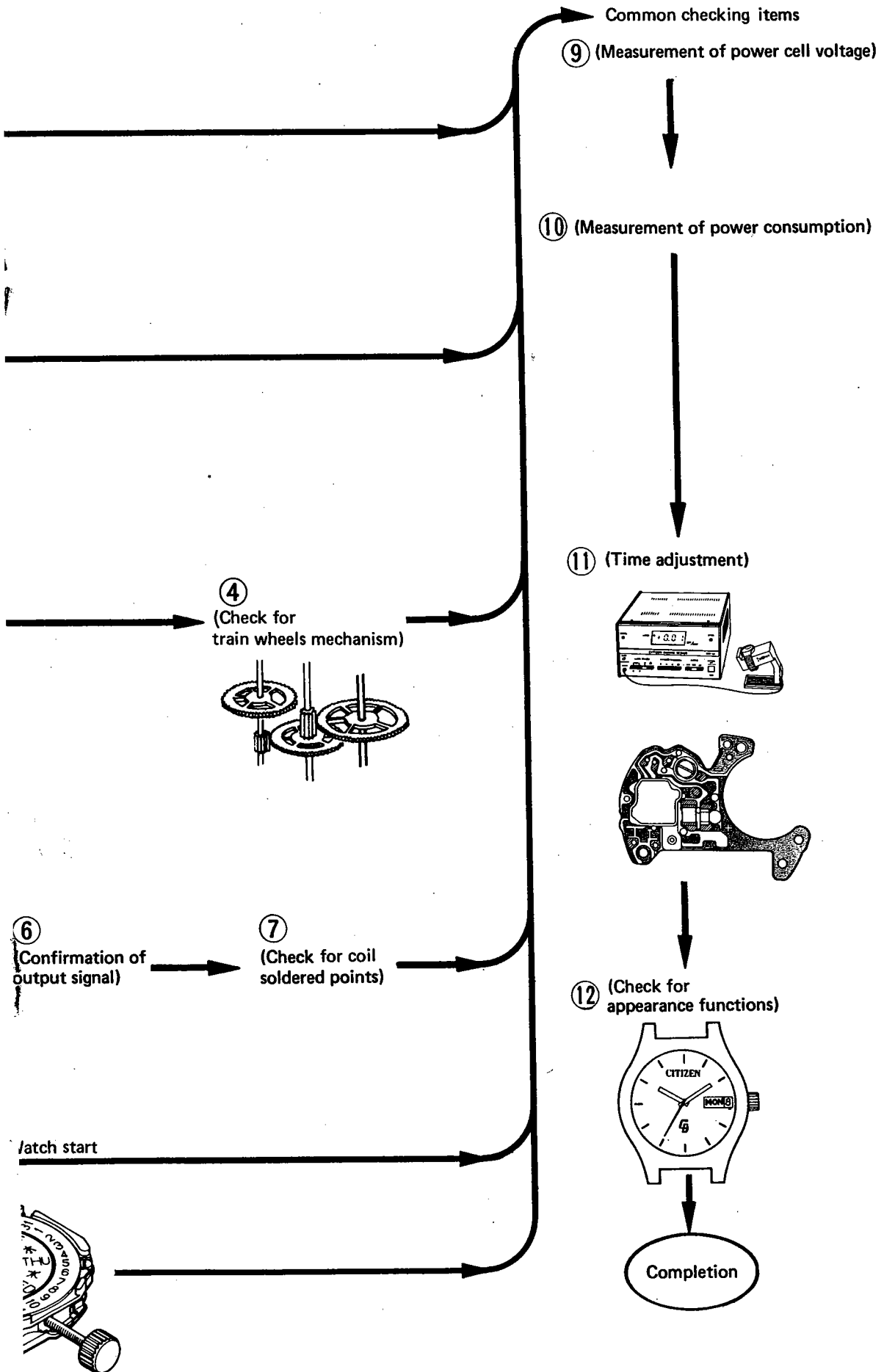

Nothing wrong with time rate

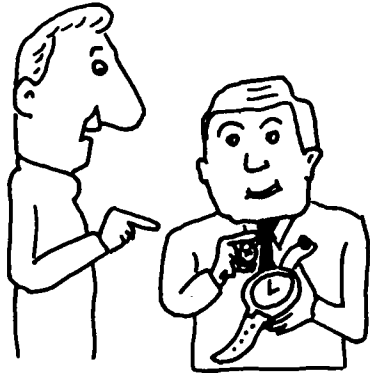
Check items	How to check	Results	Treatment
<p>1 Confirmation of using condition</p>	<p>Confirm how the watch has been used by the user.</p> <p>Ex. Didn't he make some mistakes in handling the watch?</p>		

Incorrect time rate (Big error in time rate)

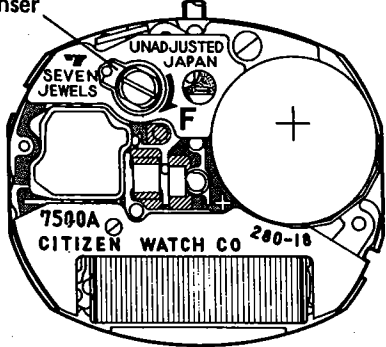
Check items	How to check	Results	Treatment
<p>2 Check for unit of electronic circuit</p>	<p>It is conceivable that the big error in the time rate is caused by a big error in the frequency of the quartz crystal oscillator which is incorporated in the unit of electronic circuit.</p> <p>So have a check in the following procedure.</p> <ol style="list-style-type: none"> <li>1) Confirm whether the time rate adjustment is possible by means of the trimmer condenser.</li> <li>2) If the time adjustment is impossible with the trimmer condenser, the quartz crystal oscillator may have some defect.</li> <li>3) The time adjustment is well possible with the trimmer condenser.</li> </ol> <p>Trimmer condenser</p> 		<p>Replacement of unit of electronic circuit</p> <p>Common checking items</p>

## Watch stop (Time rate measurement possible but no movement of hands)

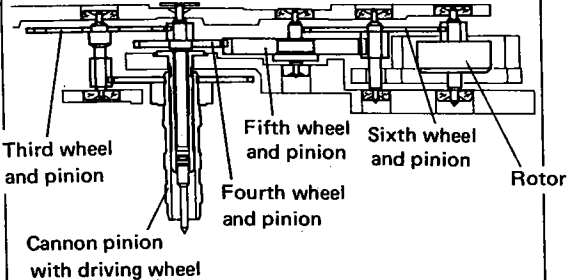
Check items	How to check	Results	Treatment
<p>3</p> <p>Check for converter</p>	<p>The converter functions to convert the energy of electrical signals into the mechanical energy. So have a thorough inspection for the following points.</p> <p>Check for rotor mechanism:</p> <ul style="list-style-type: none"> <li>• Is the amount of the play appropriate for the rotor?</li> <li>• Doesn't the rotor pinion have anything wrong?</li> <li>• Arn't there any iron filings stuck to the upper pivot of the rotor?</li> </ul> <p>Check point: In case the time rate measurement is possible in spite of no watch operation, the electrical system has no trouble. The trouble may be in the mechanical system, so a careful inspection must be given to the converter as well as the train wheels mechanism.</p>		
<p>4</p> <p>Check for train wheels</p>	<ol style="list-style-type: none"> <li>1) The amount of play must be appropriate for the sixth wheel and pinion, fifth wheel and pinion, fourth wheel and pinion, third wheel and pinion, and the cannon pinion with driving wheel respectively. No dust nor other alien objects must stick between the wheel teeth and pinion.</li> <li>2) Check whether each hole jewel has any cracks or inclination.</li> <li>3) Check the lubrication state at each area to be oiled – oil overflow, lack of oil, oil stains, etc.</li> </ol> 		

## Common checking items

5

Measurement  
of power cell  
voltage

Power cell voltage: Over 1.5V

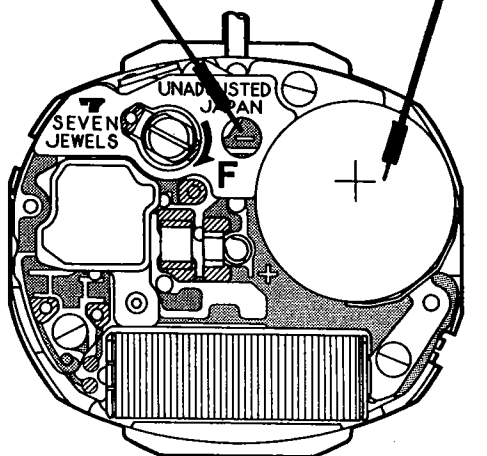
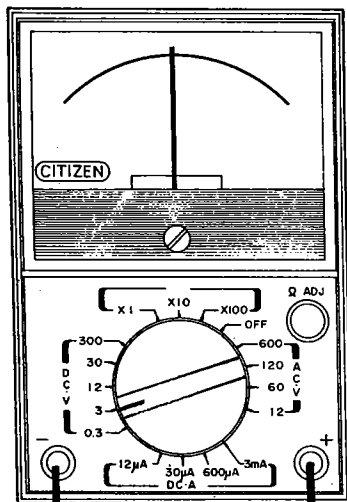

## Result and Treatment

## Over 1.5V

- No watch start  
→ ⑥ Confirmation of output signal
- Watch start  
→ ⑩ Measurement of power consumption

## Under 1.5V

Power cell is replaced:

- No watch start  
→ ⑥ Confirmation of output signal
- Watch start  
→ ⑩ Measurement of power consumption

## Note

If the watch has been used more than two years, the power cell must be replaced with new one through it shows more than 1.5V output power.

## How to Put in Power Cell

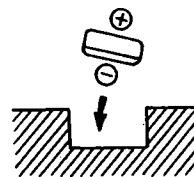

The power cell must be put into the watch with the ⊕ side up.

6 Confirmation  
of output  
signal

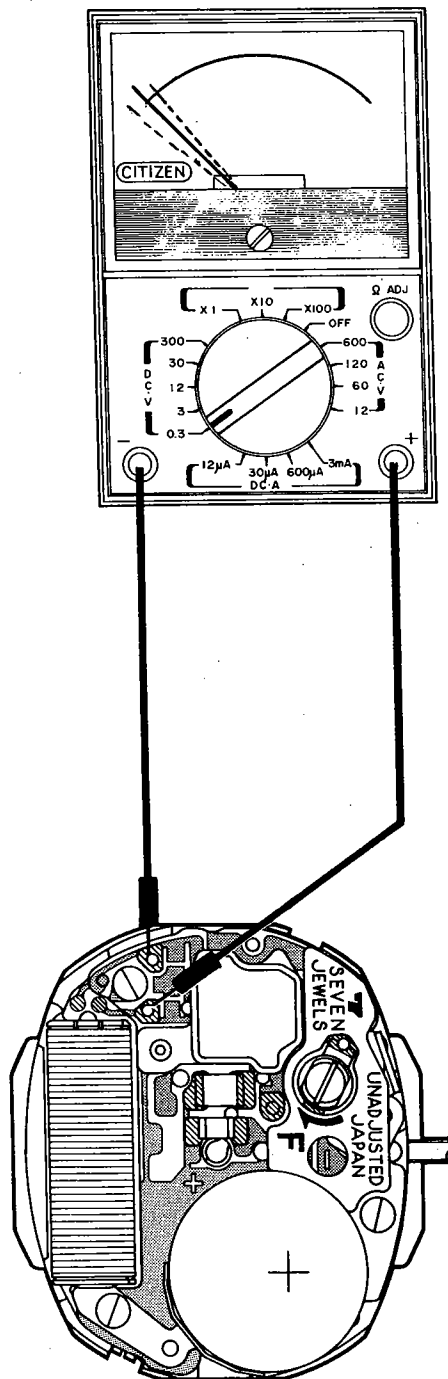

**Result and Treatment**

- The crown must be set at the normal position.
- If the meter needle goes and comes back centering on 0V, it is known that the output signal is being given.

**Output signal given**

→ ⑦ Check for coil resistance

No output signal

→ Replacement of unit of electronic circuit.

**Note**

Either of the  $\oplus$  and  $\ominus$  test leads can be applied to either of the two terminals of the watch movement.

7

Check for  
coil resistance

Coil resistance value:  $3.1\text{ k}\Omega \sim 3.5\text{ k}\Omega$

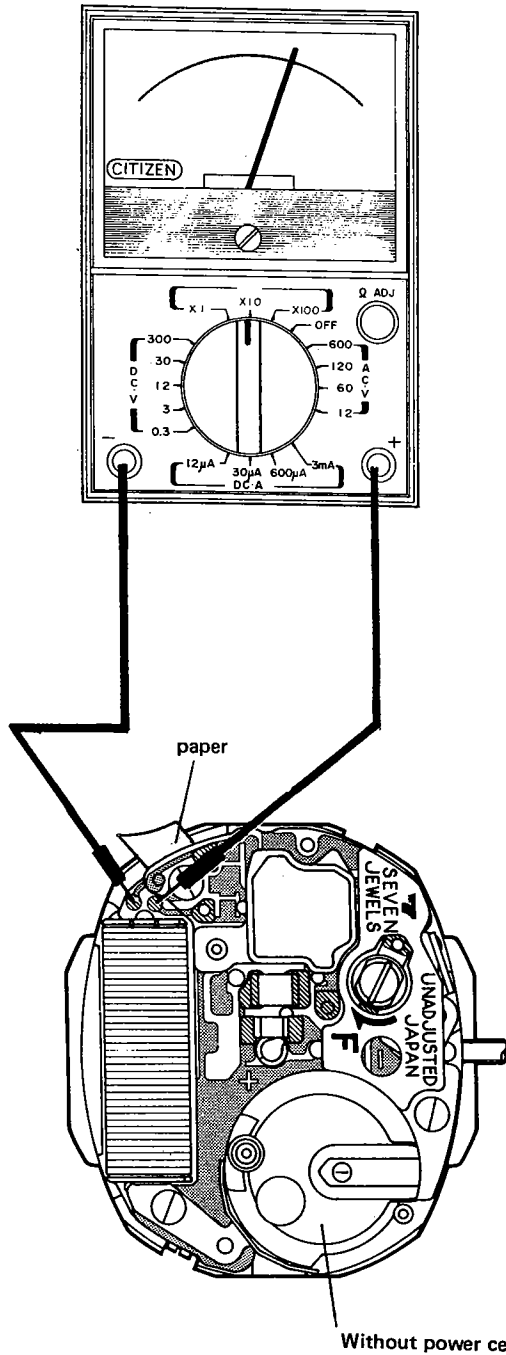

### Result and Treatment

Coil resistance value:

- Within  $3.1\text{ k}\Omega \sim 3.5\text{ k}\Omega$   
→ Common checking items
- Outside  $3.1\text{ k}\Omega \sim 3.5\text{ k}\Omega$   
→ Replacement of coil unit

### Note

- 1) Never fail to carry out the  $0\Omega$  - adjustment before measurement by giving a short circuit to both terminals of the tester.
- 2) Remove the marking plate, power cell and the screw for the unit of electronic circuit, and untighten the screw for the coil unit. Then secure an insulation by inserting a sheet of paper, etc. between the coil unit and the unit of electronic circuit prior to the measurement of the coil resistance.
- 3) Either of the  $\oplus$  and  $\ominus$  test leads can be applied to either of the two terminals of the watch movement.



Check items	How to check	Results	Treatment
<p>8 Check for dial side mechanism</p>	<p>Check for calendar mechanism:</p> <p>1. Turn the hands, and check whether the date and day change correctly.</p> <p>A. No operation of date dial</p> <ul style="list-style-type: none"> <li>● Check whether the date jumper is out of position.</li> <li>● Check whether the date dial driving finger of the date dial driving wheel has any deformation.</li> <li>● Check whether the date dial has any warp or creak.</li> </ul> <p>B. No operation of day dial</p> <ul style="list-style-type: none"> <li>● Check whether the day dial driving finger of the date dial driving wheel has any deformation.</li> </ul> <p>2. Pull out the crown by one step, and check whether the date and day can be set quickly.</p> <ul style="list-style-type: none"> <li>● Check whether the calendar corrector lever is out of position.</li> <li>● Check whether too much amount of oil is supplied to the calendar corrector wheel.</li> <li>● Check whether a sufficient amount of oil is supplied to the rubbing surface of the date dial of the calendar plate.</li> </ul>	<p>Date jumper out of position →</p> <p>Driving finger deformed →</p> <p>Driving finger deformed →</p> <p>Corrector lever out of position →</p> <p>Too much oil supplied →</p> <p>Shortage of oil supply →</p>	<p>→ Reassembling</p> <p>→ Replacement of date dial driving wheel</p> <p>→ Replacement of date dial driving wheel</p> <p>→ Reassembling</p> <p>→ Cleansing</p> <p>→ Lubrication</p>

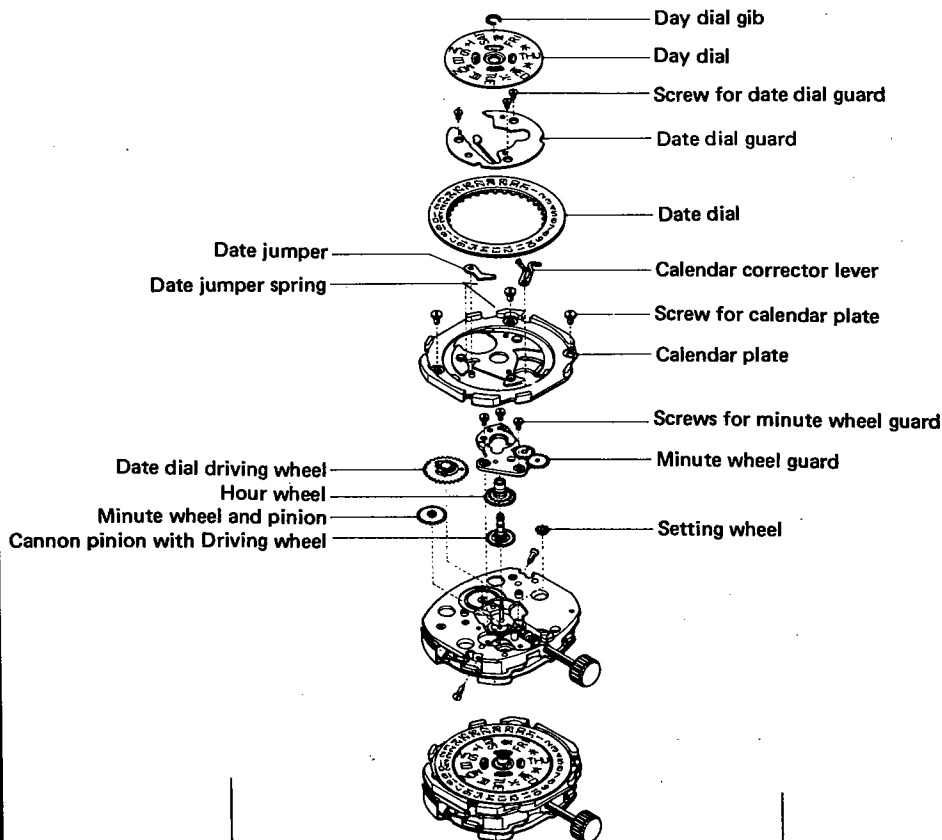

Common checking items

9 Measurement of power cell voltage

Power cell voltage: Over 1.5V

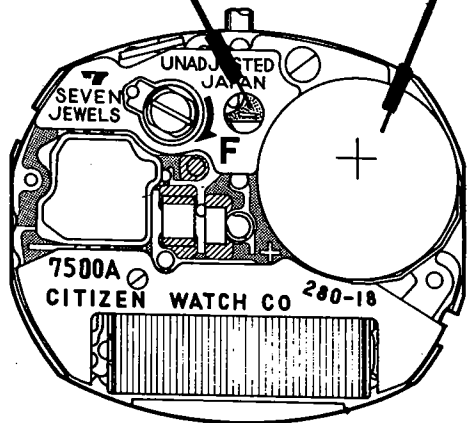
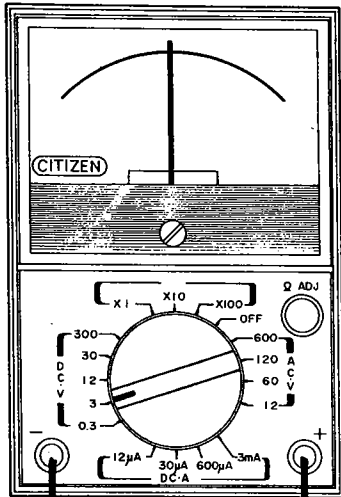

Result and Treatment

Over 1.5V

- No watch start  
→ ⑥ Confirmation of output signal
- Watch start  
→ ⑩ Measurement of power consumption

Under 1.5V

Power cell is replaced:

- No watch start  
→ ⑥ Confirmation of output signal
- Watch start  
→ ⑩ Measurement of power consumption

Note

If the watch has been used more than two years, the power cell must be replaced with new one even through it shows more than 1.5V output power.

How to Put in Power Cell

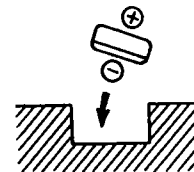

The power cell must be put into the watch with the ⊕ side up.

10 Measurement of power consumption

Power consumption: Under  $4.0\mu\text{A}$

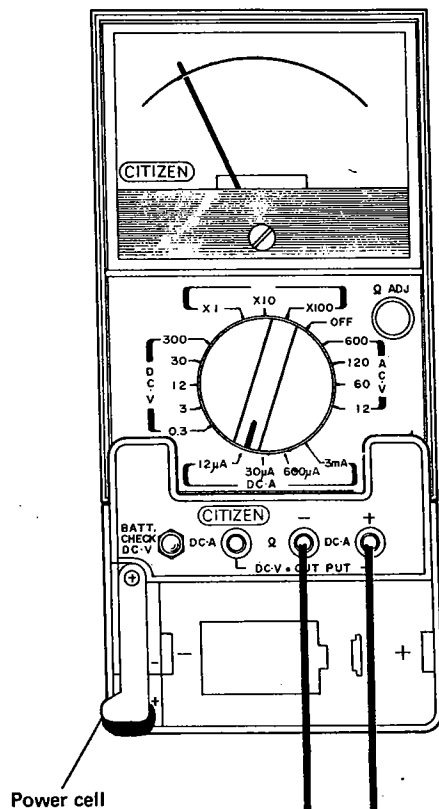

Power cell

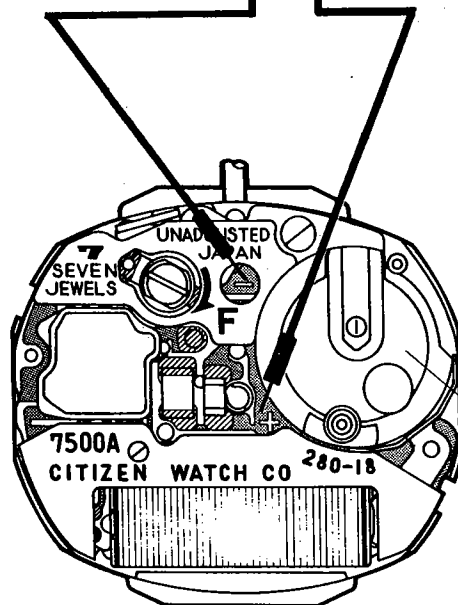

Without power cell

**Result and Treatment**

- 1) Reading of power consumption in normal state:

**Under  $4.0\mu\text{A}$**

- ① Time adjustment

**Over  $4.0\mu\text{A}$**

- 2) Measurement of power consumption under power-conservation state

- 2) Measurement of power consumption under power-conservation state (Crown set at time setting position):

**Under  $2.0\mu\text{A}$**

- ③ Check for converter

**Over  $2.0\mu\text{A}$**

- Replacement of unit of electronic circuit

**Note**

Never fail to install a power cell of 1.5V or more into the power cell holder of the adaptor.

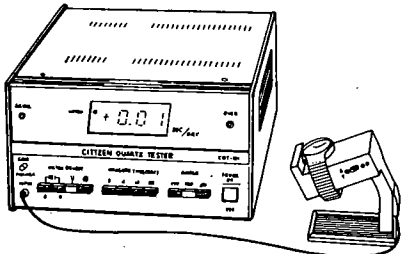
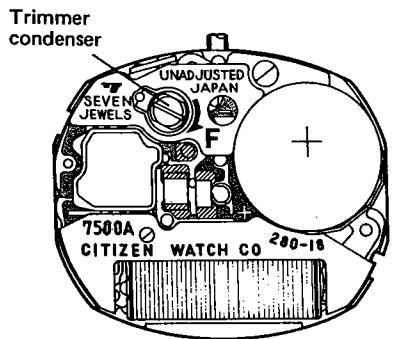
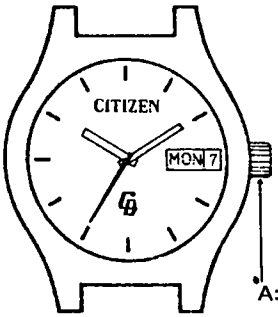
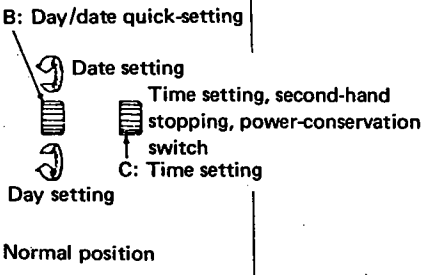
Check items	How to check	Results	Treatment
<p><b>11</b> Time adjustment</p>	<p>Carry out measurement of the time rate using a timing machine.</p>  <p>When carrying out the time adjustment, follow the instruction below.</p> <ul style="list-style-type: none"> <li>The time adjustment can be performed by turning right or left the screw of the trimmer condenser.</li> </ul> 		
<p><b>12</b> Check for appearance functions</p>	<p>Carry out a check for the appearance functions by making sure the following points.</p> <ul style="list-style-type: none"> <li>The hand turning must be performed smoothly.</li> <li>The operation must be smooth and accurate for the time setting, second-handstopping and power-conservation switch respectively, with the crown pulled out two steps (C position).</li> <li>The date and day must be set quickly and correctly, with the crown pulled out one step (B position).</li> </ul>   <p>(The explanation of the drawing is of 7500A)</p>		

**CITIZEN WATCH CO., LTD.**  
Tokyo, Japan